

**LED Downlight - Domag**

Model

**HC101 - stropné, prisadené svietidlo**



Rozmery	Ø80 x 163 mm
Napájanie	230VAC
Výkon	10W
Typ LED	1x10W Multi-chip
Farba svetla	teplá biela, studená biela
Vyžarovací uhol	90°
Svetelný tok	550 - 650 lm
Driver	súčasťou
Povrchová úprava	aluminum alloy-oxidized finish
Poznámka	

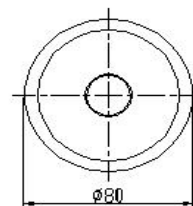
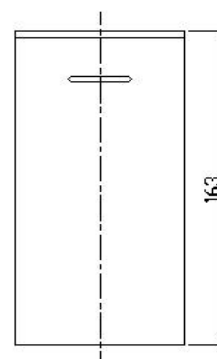

MIKRA svetlo inak, s.r.o. Zimná 94, 052 01 Spišská Nová Ves

**LED Downlight - Domag**

Model

**HR-101B / HR-102B / HRN-101B - stropné, zapustené svietidlá**



Rozmery	Ø103x80x80 mm
Napájanie	230VAC
Výkon	10W
Typ LED	1x10W Multi-chip
Farba svetla	teplá biela, studená biela
Vyžarovací uhol	HR101 - 90° / HR102 - 120° / HRN101 - 60°
Svetelný tok	550 - 650 lm
Driver	externý IP66
Povrchová úprava	B1 - lesklá, B2 - matná, B3 - biela
Príslušenstvo	
Montážny otvor	Ø95 mm
Poznámka	

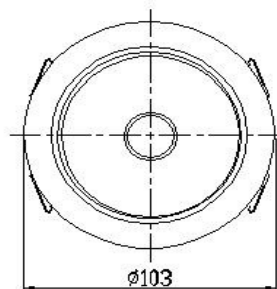
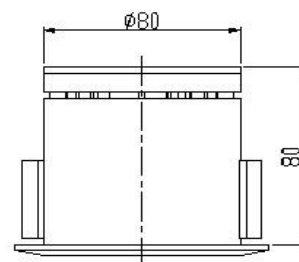

B1



B3



**LED Downlight - Domag**

Model

**C75R1 - stropné, zapustené svietidlá**



Rozmery	Ø103x75x100 mm
Napájanie	230VAC
Výkon	13W
Typ LED	1x13W Multi-chip Citizen CRI 85
Farba svetla	teplá biela, studená biela
Vyžarovací uhol	82°
Svetelný tok	960 - 1100 lm
Driver	externý IP66
Povrchová úprava	B1 - lesklá, B2 - matná, B3 - biela
Príslušenstvo	
Montážny otvor	Ø95 mm
Poznámka	

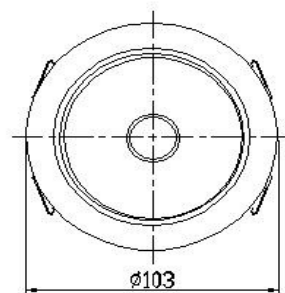

## LED Downlight - Domag

Model

**HR-101C**

**HR-101D**

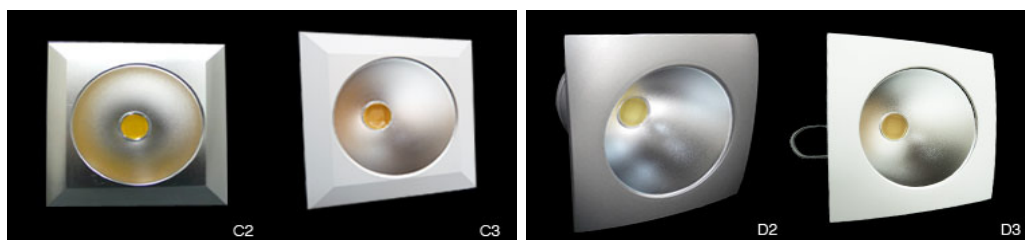

Rozmery	105x105x90 mm	105x105x90 mm
Napájanie	230VAC	230VAC
Výkon	10W	10W
Typ LED	1x10W Multi-chip	1x10W Multi-chip
Farba svetla	teplá biela, studená biela	teplá biela, studená biela
Svetelný tok	550 - 650 lm	550 - 650 lm
Driver	externý IP66	externý IP66
Montážny otvor	95 mm	95 mm
Povrchová úprava	C2 - matná, C3 - biela	D2 - matná, D3 - biela
Materiál	extrude aluminum	extrude aluminum
Vyžarovací uhol	HR-101C - 90° HR-102C - 120° HRN-101C - 60°	HR-101D - 90° HR-102D - 120° HRN-101D - 60°

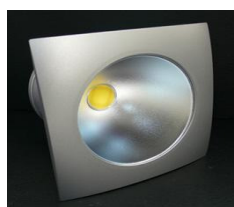

**LED Downlight - Domag**

Model

**HRB séria - stropné zapustené svietidlá**

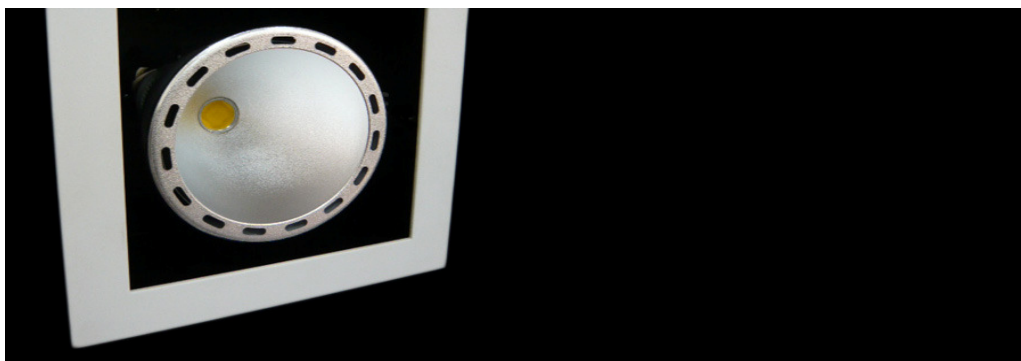

Rozmery

Napájanie

Výkon

Typ LED

Farba svetla

Vyžarovací uhol

Svetelný tok

Driver

Povrchová úprava

Svetelný zdroj

Stmievanie

230VAC

1x10W, 2x10W, 3x10W, 4x10W

1x10W Multi-chip

teplá biela, studená biela

80°

550 - 650 lm

externý IP66

extrude aluminum - oxidized finish

E27

switch on/off ( 10W-7W-5W-2W )

HRB-101 195x195x190

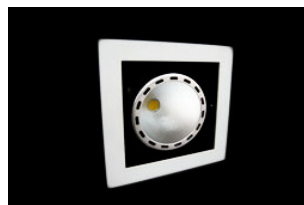

HRB-201 348x195x190

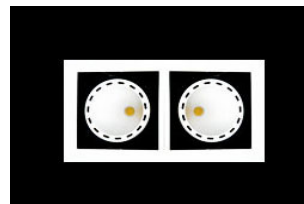

HRB-301 500x195x190

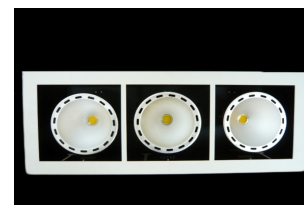

HRB-401 348x348x190

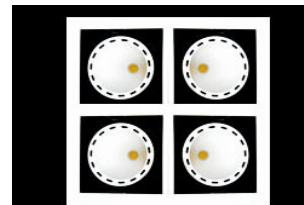

## LED Downlight - Domag

Model

**HR-051-B1 - stropné, zapustené svietidlo**



Rozmery	Ø88x68x40 mm
Napájanie	230VAC
Výkon	5W
Typ LED	1x5W Multi-chip
Farba svetla	teplá biela, studená biela
Vyžarovací uhol	140°
Svetelný tok	200 - 260 lm
Driver	externý IP66
Povrchová úprava	extrude aluminum - oxidized finish
Difuzor	foggy sklo
Montážny otvor	Ø 75 mm
Poznámka	

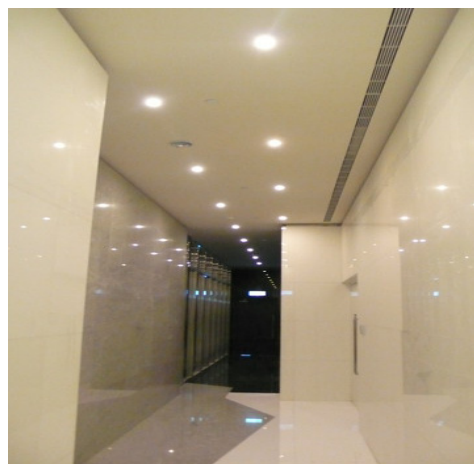
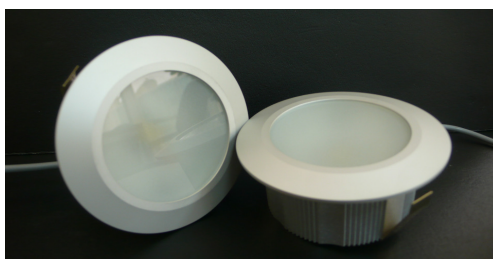
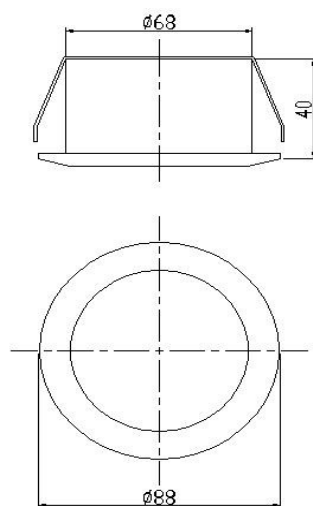

LED Downlight - Domag

Model

**HTR-101 - lištové svietidlo**

**HD-401 - závesné High Bay**



Rozmery

Ø100x150 mm

Ø360x420 mm

Napájanie

230VAC

230VAC

Výkon

10W

40W

Typ LED

1x10W Multi-chip

4x10W Multi-chip

Farba svetla

teplá biela, studená biela

teplá biela, studená biela

Vyžarovací uhol

HTR-101 - 90° / HTR-102 - 120°

90°

Svetelný tok

550 - 650 lm

2500 - 2800 lm

Driver

externý IP66

vstavaný IP66

Povrchová úprava

extrude aluminum - oxidized finish

aluminum oxidized - painting finish

Poznámka



## LED Downlight - Domag

Model

**BOOM-101 - žiarovka PAR38**



Rozmery	Ø120x167 mm
Napájanie	230VAC
Výkon	10W
Typ LED	1x10W Multi-chip / E27
Farba svetla	teplá biela, studená biela
Vyžarovací uhol	80°
Svetelný tok	550 - 650 lm
Povrchová úprava	extrude aluminum - oxidized finish
Reflektor	aluminum oxidized
Farebná úprava	červená, zlatá, strieborná
Stmievanie	typ BOOM-101-D
Stmievanie	switch on/off ( 10W-7W-5W-2W )

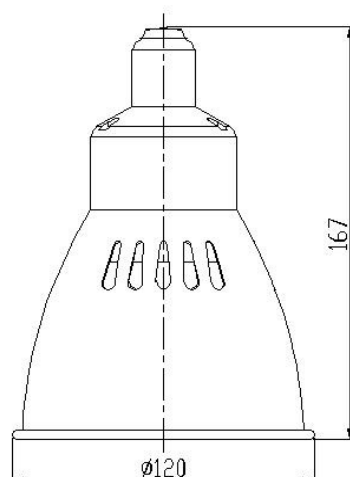

MIKRA svetlo inak, s.r.o. Zimná 94, 052 01 Spišská Nová Ves

## LED Spotlight - Domag

Model

**FF-101**

**HF-071**



Rozmery

Ø100x230x145 mm

Ø80x68x80 mm

Napájanie

230VAC

24VDC

Výkon

10W

7W

Typ LED

1x10W Multi-chip

1x7W Multi-chip

Farba svetla

teplá biela, studená biela

teplá biela, studená biela

Vyžarovací uhol

60°

60°

Svetelný tok

550 - 650 lm

420 lm

Povrchová úprava

aluminum

extrude aluminum/hard oxidized

Difúzor

5mm číre sklo

5mm číre sklo

Krytie

IP55

IP68

Driver

vstavaný

externý

Poznámka

aj verzia ako podhladinové alebo zemné

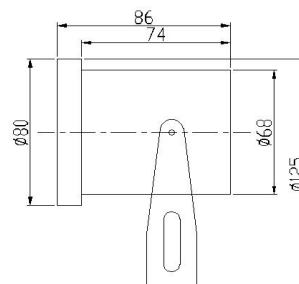
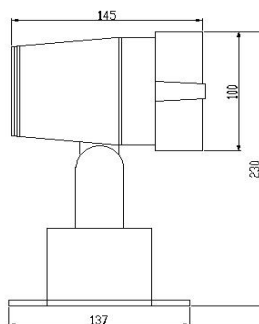

MIKRA svetlo inak, s.r.o. Zimná 94, 052 01 Spišská Nová Ves

LED Downlight - Domag

Model

**AD-1 závesné svietidlo**



Rozmery	Ø160x230 mm
Napájanie	230VAC
Výkon	10W
Typ LED	1x10W Multi-chip / E27
Farba svetla	teplá biela, studená biela
Vyžarovací uhol	80°
Svetelný tok	550 - 650 lm
Povrchová úprava	aluminum
Stmievanie	switch on/off ( 10W-7W-5W-2W )
Driver	vstavaný
Kábel	1 m
Poznámka	